

Rugged Textiles

cp cases 



Rugged Textiles

Introducing Rugged Textiles

The need to protect equipment, during use or transit, using light, tough, flexible materials is a common requirement for the military, law-enforcement, emergency services, medical care, oil and gas and broadcast media sectors and no-one has a more diverse capability to support that need than CP Cases.

From a simple bag for a corporate promotion to a highly complex protective cover for an outside broadcast camera, CP Cases designs and manufactures a vast range of rugged textile and flexible material solutions.

Contents

- 2 Overview
- 4 Design and Production Process
- 6 Bag Types
- 8 Features
- 9 Applications
- 10 Manufacturing Process
- 12 Other CP Products and Services

Overview

CP Cases' rugged textile products protect portable electronics equipment, surgical and analytical instruments, professional broadcast cameras, audio apparatus, engineering tools, personal equipment for defence and security professionals and many other applications where the user is looking for a light-weight protection option.

CP Cases' bespoke design and manufacturing processes deliver the finest customised solutions for protecting personal equipment during use and transit.

Mostly made-to-measure, CP Cases also offers a superior range of standard off-the-shelf items for professional equipment.

The UK based design and textiles teams, using the latest CAD pattern making tools, are able to present clients with a full design service from initial

concept sketches through detailed renders right up to production prototype samples and finally full production. CP Cases design and develop clients' custom bags every step of the way while maintaining close consultation with the customer.

The flexible approach means that while small production runs in the UK with short lead times for design and delivery are supported, larger scale programme management and manufacture can be provided if required.

While practical, tough and lightweight, the aesthetic aspects are never overlooked, and each creation helps maintain the customers' image and reputation; rugged textiles and flexible materials also lend themselves to many colour and labelling and branding options, including embroidery and screen-printing, to aim in producing a stylish product.

Sectors supported

To meet the varied needs of broadcast professionals – from electronic news gatherers and freelance cameramen to high-end broadcasters – a wide range of bags and cases is available, with practical designs using quality tested materials to protect equipment and provide ease of use.

Hire companies dominate a demanding audio-visual market with requirements for tough multi-trip cases and bags to protect projectors, recorders, monitors, plasma screens, computers and microphones.

Satellite communication equipment suppliers need to deliver vital equipment used in remote locations around the world and CP Cases provide robust lightweight solutions for civil and military users alike.

Security agencies have a vast range of capabilities that require specialised bags and cases to protect and transport equipment. Forensics teams, surveillance units and operational groups have all benefited from CP Cases' made-to-measure solutions for the toughest applications.



Our design team draws on years of experience with protective textiles to create the most cost-effective bag for your needs



Design and Production Process

The process starts with extensive consultation with the client to determine the requirement; equipment to be contained, environment of use, quantity required, etc.

CP Cases' designers then measure the equipment and construct digital models to create solutions around.

Continuing the consultation process, prototypes are often made to ensure the best possible design and confirm the best manufacturing process before moving to full production.

In addition to small runs, CP Cases also is a master in programme and product management, facilitating the design, prototyping, sampling and mass production of bags and other non-rigid containers.

Acting as the design authority, and working with our international partners, CP Cases programme management skills allows the client to hand over the entire project, mitigating any risk, and allowing an expert to control the whole process. This complete in-house capability means CP Cases will deliver the very best and most cost-effective solution, on time, every time.

CP Cases' consolidated capability means that client need only rely on one organisation to design, prototype, test and manage the whole production process.

For quantities greater than 500 bags, designs and prototypes are created in the UK, using the latest computer technology and then manufactured to the highest standards in South East Asia, using extensive experience of managing production to gain a price advantage without compromising materials and quality.

1) Design consultancy

This flowchart outlines the steps taken when planning a new project

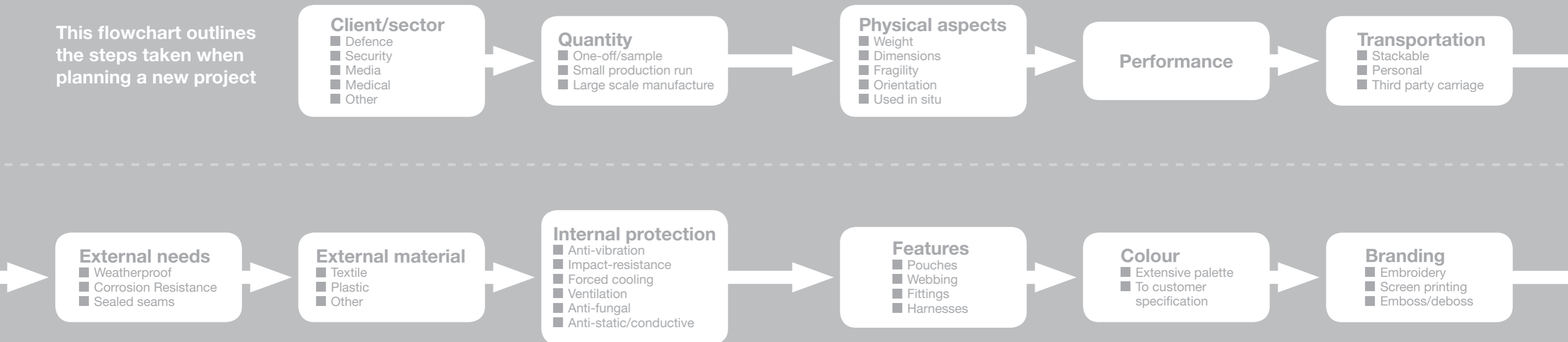

2) Assessment and approval

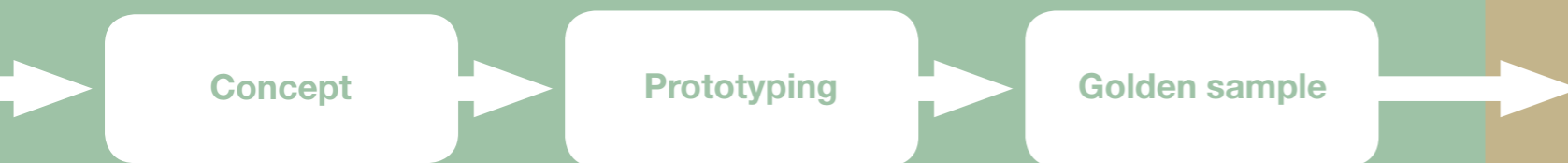

3) Programme management

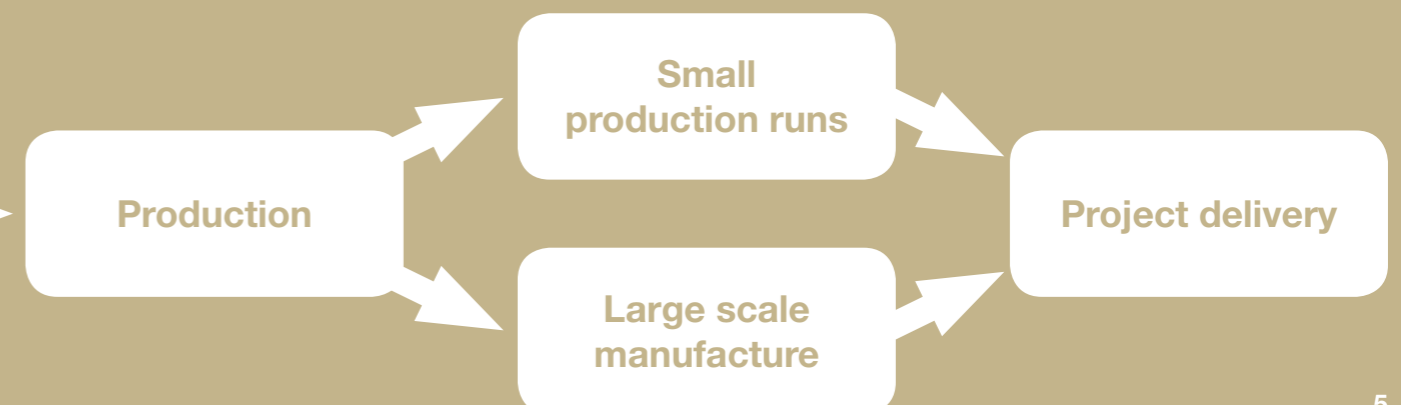

Bag Types

Standard flapped bag
(1 flap)

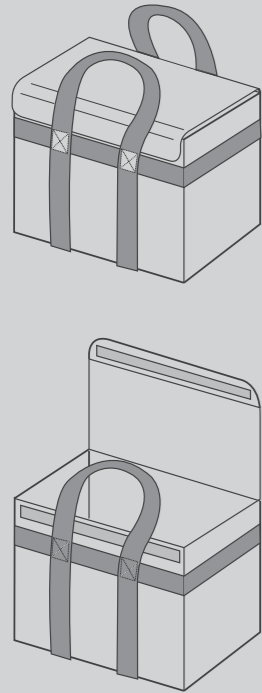

Standard flapped bag
(3 flaps)

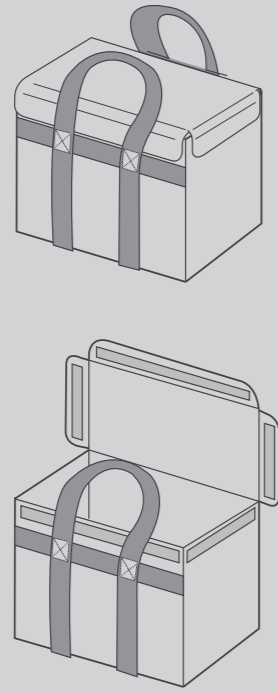

Standard flapped bag
(dual interior flaps)

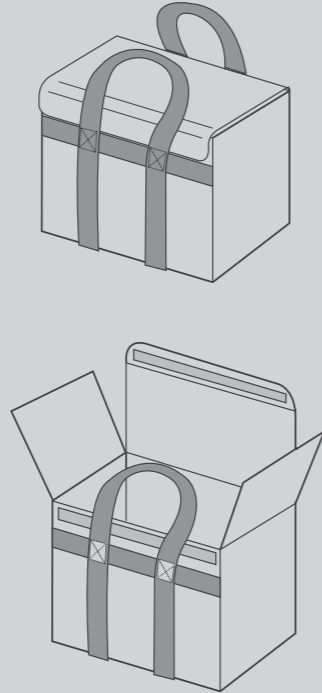

Standard flapped bag
(briefcase)

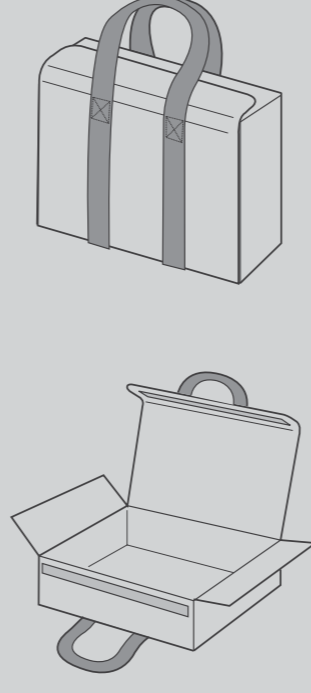

CP piped
briefcase

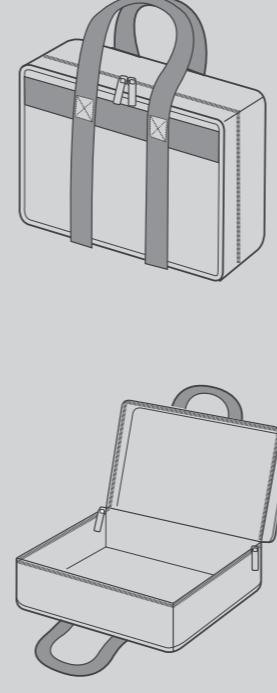

G-style
briefcase

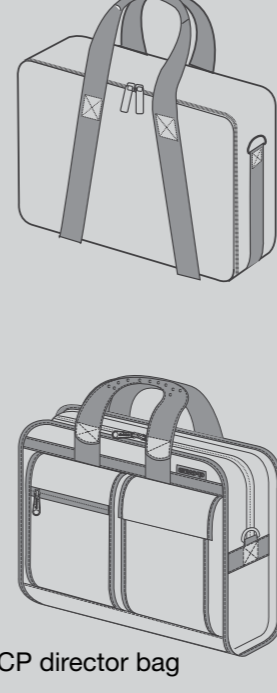

Backpack with
piped construction

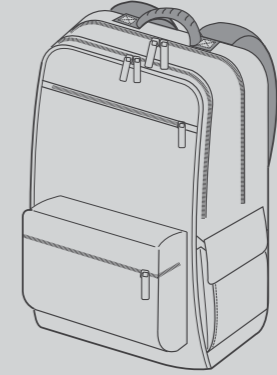

Wheeled
rolling case
with
telescopic
handle

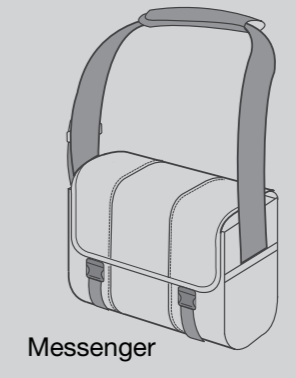
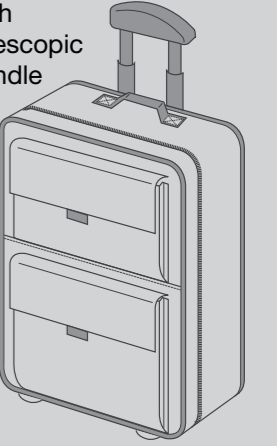

Messenger

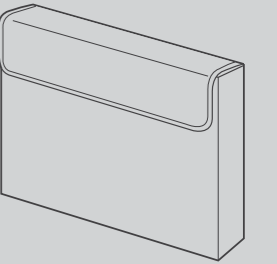

Folio

Astro
case

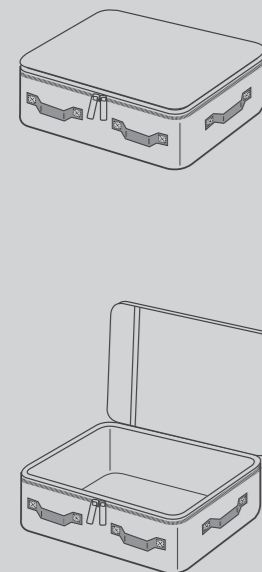

Standard single skin
piped foampack bag

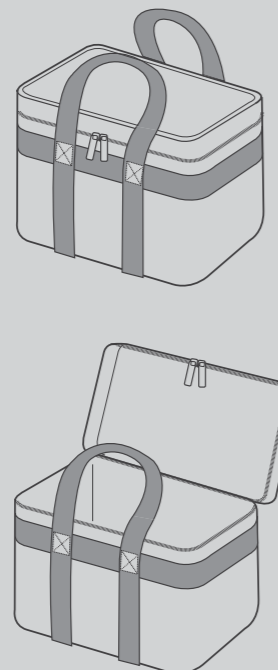

Standard zipped
briefcase

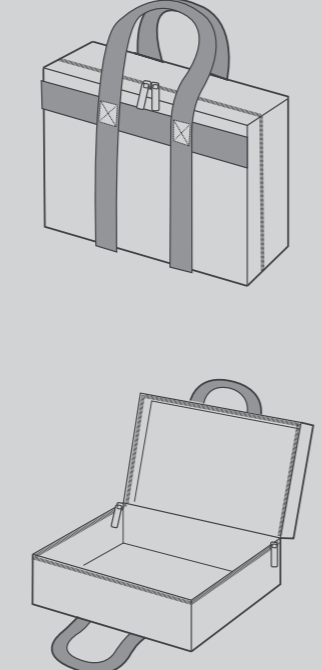

Standard zipped
bag

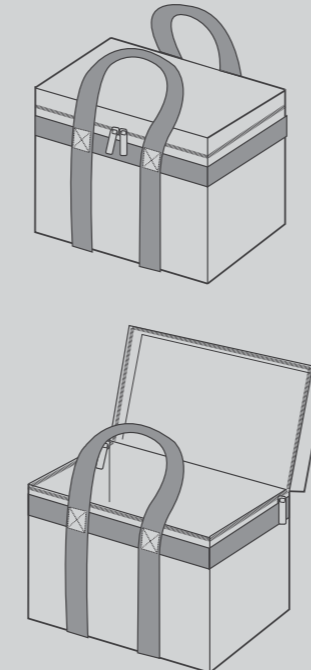

CP foam pack
piped split bag

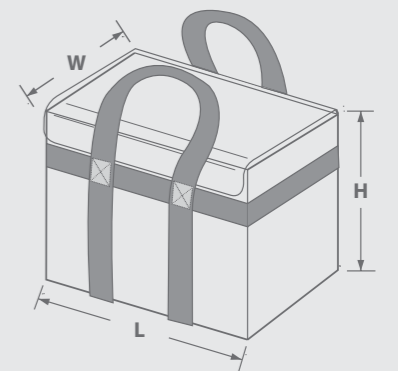
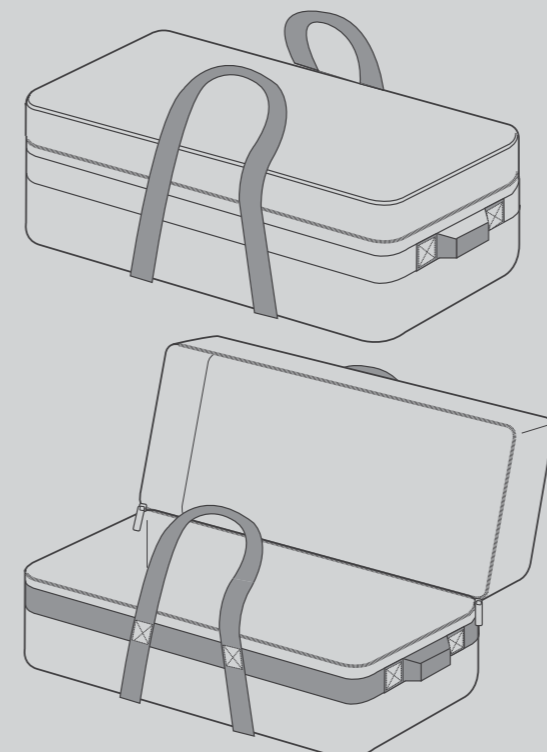

Dimension Reference

All textile products use standard measuring convention. Dimensions are external.













Fully customised versions of all types are available. Please contact us for details.

Features

Bespoke design

As with all its products, CP Cases offers a complete service to suit individual requirements and create bespoke designs. The extensive range in designing and manufacturing ruggedised bags and flexible containers means they can provide practical solutions for unique applications, when a robust container is required for deployment, transport or storage.

This approach means each product is distinct and unique and can incorporate features, components and benefits specific to the user's needs.

-  **Webbing** Different weights of webbing deliver the best solution for the client
-  **Padding** Designed to be comfortable as well as functional
-  **Handles** A range of handle designs to suit the requirements of the user
-  **Slings** Heavy duty slings and industrial needs catered for
-  **Clasps and clips** Metal and plastic fasteners and clasps deliver
-  **Closures** Highest quality zips, studs, poppers and Velcro provide the best closing solutions
-  **Plastics** Polypropylene structures can be made to support soft bags or provide extra resilience
-  **Materials** Tough Cordura, nylon and canvas fabrics used to maintain a long operational life
-  **Colours** A vast range of colours and patterns are supported
-  **Foam** Specialist foam design to provide tailored cushioning in high quality "closed-cell" polyethylene foam
-  **Mobility** Incorporating wheels, telescopic handles and other mobility features, provide convenience to the user
-  **Stitching** Heavy duty stitching provides a long life in the most extreme circumstances
-  **Labelling** Rugged textiles and flexible materials lend themselves to a range of labelling and branding options



Webbing

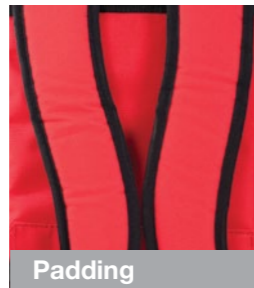

Padding



Handles

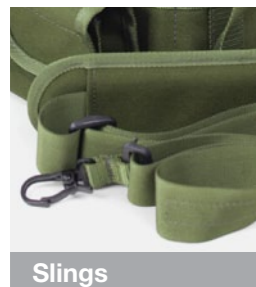

Slings



Clasps

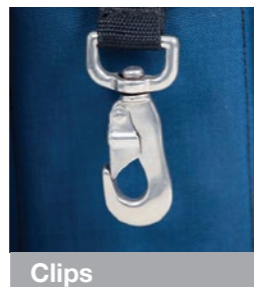

Clips

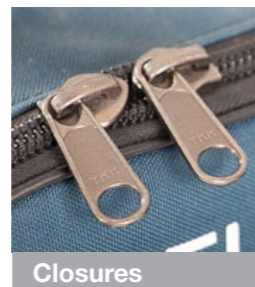

Closures

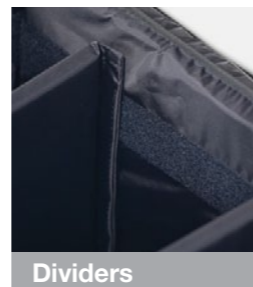

Dividers

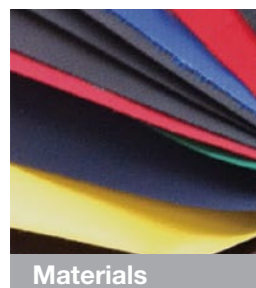

Materials

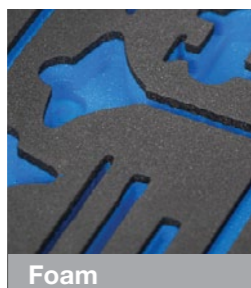

Foam

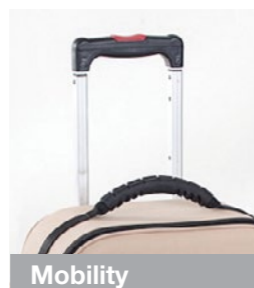

Mobility

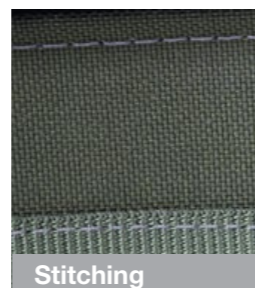

Stitching

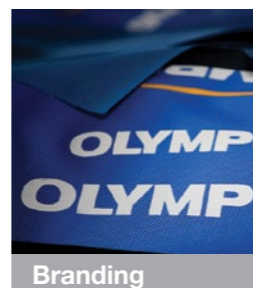

Branding

Rugged Textile Applications

Certification and accreditations are available on request



Manufacturing Process

CP Cases' rugged textile and flexible material products are hand-made by some of the most experienced and best trained personnel in the business.

Products are hand cut or punched using traditional methods from the best and most suitable materials to exact custom design patterns and then hand stitched ensuring the highest quality and most hard-wearing finish.

Fittings, piping, straps, webbing and other features are then secured before foam inserts, produced on-site and designed to be part of the complete product, are applied.

Final checking and cleaning then takes place before the finished item is shipped to the customer.



Textile cutting



Stitching



Foam engineering



Precision cutting



Branding



Finishing



Applications in

- Satellite Uplinks
- Secure Telecommunications
- Offshore & Geophysical
- Maritime
- Aerospace

Other CP Products and Services

Climate Control

CP Cases Climate Control is a new offering covering air conditioning and climate control units for use in CP Cases' Amazon Cases & Racks, ERack and SatRack ranges or for integration into customised rack solution.

Delivered either as a COOL-Collar or as an integrated unit, CPCC provides a one-stop-shop for 19" rack mount cases complete with air conditioning to maintain

equipment's optimal operating conditions. Available in thermoelectric, for heating as well as cooling, and vapour compression, for high efficiency and volume, formats.

All CP Cases Climate Control units can be fitted with accessories including stowage pouches, wheel kits, pressure relief valves and humidity indicators.



COOL-COLLAR™

COOL-COLLAR™ is an air conditioning capability for 19" racks that utilises the patented Amazon lip and silicone gasket to create an airtight and waterproof seal to allow the unit to function in extreme conditions. The unit is attached to an existing rack to maintain an optimum operation temperature for equipment.

Where a greater cooling requirement is needed, two COOL-COLLARs™ with AC units can be fitted to both the front and rear of the rack. Units are available up to 5000 BTU (1465 watts) which can be fitted to 12U racks and collars.



Integrated Units

Built directly into the rack system, these climate control units provide cooling and heating, when required, automatically when temperature perimeters are met. Normally end-mounted, CP Cases offer the capability to integrate in a range of orientations to fit client requirements.



SatRack™



Designed for Electronic News Gatherers and Media Professionals, operating across the globe, SatRack is a lightweight solution that can be hand carried on commercial airlines as checked luggage, saving time and avoiding additional baggage charges for those who need

delicate electronic and satcom equipment to be quickly deployable and available immediately.

SatRack's novel and patented design is available in standard sizes of 3U, 4U and 5U versions with a 480 or 610mm deep, ultra-lightweight welded aluminium floating frame and is fully compatible with all 19-inch rack-mountable equipment. This design offers an exceptional strength-to-weight ratio and equipment panel fixing rails located at both ends of the frame allow for flexible mounting of kit. (Also available for 9.5-inch racks.)

Aluminium Cases



A triumph of strength and style, CP Cases aluminium cases protect their contents even under severe impact and are tougher, lighter and more resilient than traditional designs in laminated plywood.

CP Cases aluminium cases are the ideal balance between style and protection. Made from 2mm rigidised aluminium, cases are constructed without an edge corner weld to prevent seam splitting and the pre-pressed corners add extra strength and exceptional resistance to drop damage.

The inter-locking lid/body seal, with an integrated neoprene rubber gasket, protects contents against rain, dirt, dust and other environmental hazards.

Custom Solutions



CP Cases' design team can create a solution for any application that you or your products require. Designers are equipped with state-of-the-art capabilities and have extensive experience in diverse manufacturing processes including rotomoulding, blow moulding and injection moulding, vacuum forming, precision sheet metal work and traditional craft skills in a wide range of materials.

ERack®



ERack is a lightweight, 19-inch ruggedised aluminium electronic transit rack, specifically designed for commercial and military applications when protection against physical, climatic and electromagnetic hazards are required, and where weight, strength and portability are critical issues.

ERack benefits from patented new technology; the external container has an innovative folded rim design, which eliminates the edge extrusion and makes the case stronger, lighter and more resistant to ingress by water and dust. The internal chassis frame is supported by special mounts that protect against shock. ERack is up to 30% lighter than other rack cases in its class.

Amazon Cases & Racks™



Ideal for defence, marine, security, aerospace, oil and gas, satellite and telecommunication applications worldwide, Amazon Cases and Racks deliver exceptional strength to weight and are suitable where delicate or valuable equipment

needs to be transported or stored safely.

Amazon Cases and Racks have a unique patented design that offers a tough, lightweight, customisable system that can be tailored to the client's requirements and individual needs.

Foam Engineering



CP Cases can create foam protection systems to meet exacting project requirements for colour, multi-layering and special properties, by a variety of processes, including high speed CNC routing, laminating, drilling,

blocking and hand sculpting. Calculating which density and composition of foam to use and the exact thickness required to produce the desired deceleration on impact, ensures the best protection possible.



CP Cases Ltd

Unit 11 Worton Hall Industrial Estate | Worton Road | Isleworth | Middlesex | TW7 6ER | UK
Tel: +44 (0) 20 8568 1881 | Fax: +44 (0) 20 8568 1141
www.cpcases.com

**TRUSTED
WHEN IT
MATTERS**

About CP Cases

CP Cases designs and manufactures high-performance, protective cases and racks used for transport, operation and storage of essential equipment in commercial and military applications.

Many of our products are accredited to MIL-STD-810F, rated IP65 and carry NATO stock numbers. With over 40 years' of expertise in producing cases, 19-inch rack solutions and rugged textile products, CP Cases has an unparalleled range of in-house skills and knowledge with materials and processes, including rotationally moulded products, plastic fabrication, aluminium, laminated plywood, HPP, textiles and CNC foam machining.

Full Capability Statement available on request.

Distributed by

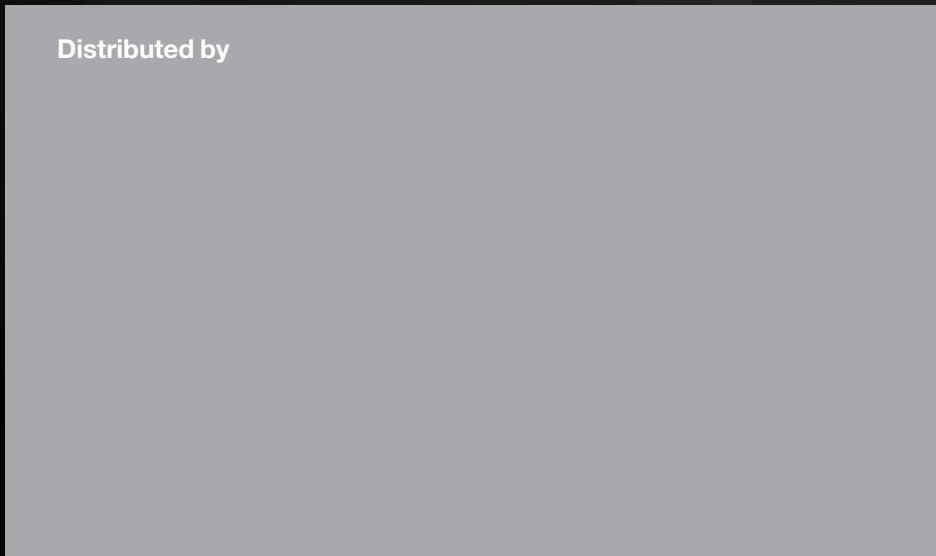

21st century supply chains



@cpcases



www.cpcases.com/blog



Follow us



Search CPCASES

